



# ENAPART



93 S Railroad Avenue Unit C  
Bergenfield NJ 07621 USA  
[www.enapart.com](http://www.enapart.com)  
[sales@enapart.com](mailto:sales@enapart.com)



Via del Canneto 35,  
Borgosatollo, Brescia - Italia  
[www.enapart.it](http://www.enapart.it)  
[vendite@enapart.it](mailto:vendite@enapart.it)



Barbaros Mah. Ihlamur Bul. Aĝaoĝlu  
My Newwork No:3/15 Ataşehir / İstanbul  
[www.enapart.net](http://www.enapart.net)  
[satis@enapart.net](mailto:satis@enapart.net)



PRIVADA 10 B SUR #3908 COL.  
ANZUREZ, C.P. 72530, PUEBLA, PUE  
[www.enapart.com.mx](http://www.enapart.com.mx)  
[sales@enapart.com.mx](mailto:sales@enapart.com.mx)



Friedrich-Ebert-Anlage 36, 60325  
Frankfurt am Main, Germany  
[www.enapart.de](http://www.enapart.de)  
[anfrage@enapart.de](mailto:anfrage@enapart.de)



4 boulevard Carnot, 95400  
villiers-le-bel, Paris, France  
[www.enapart.fr](http://www.enapart.fr)  
[sales@enapart.fr](mailto:sales@enapart.fr)



65049, ОДЕСА, ВУЛИЦЯ ІВАНА  
ФРАНКА, БУДИНОК 55, ПОВЕРХ 3  
[www.enapart.com.ua](http://www.enapart.com.ua)  
[sales@enapart.com.ua](mailto:sales@enapart.com.ua)



MUNICIPIUL BUCUREȘTI, SECTOR 3,  
B-DUL BASARABIA, NR.250, CORP P+5  
[www.enapart.ro](http://www.enapart.ro)  
[sales@enapart.ro](mailto:sales@enapart.ro)



〒584-0023 大阪府富田林市若松町  
東2丁目2番16号  
[www.enapart.co.jp](http://www.enapart.co.jp)  
[sales@enapart.co.jp](mailto:sales@enapart.co.jp)



PLAZA NUESTRA SEÑORA DE LAS  
NIEVES 12 ,LOCAL ,50012,ZARAGOZA  
[www.enapart.es](http://www.enapart.es)  
[ventas@enapart.es](mailto:ventas@enapart.es)



Складова база „Онџл“, Склад А2, п.к.  
4006, гр. Пловдив, България  
[www.enapart.bg](http://www.enapart.bg)  
[sales@enapart.bg](mailto:sales@enapart.bg)



3 Austin Mews, High Street, Hemel  
Hempstead, HP1 3AF , United Kingdom  
[www.enapart.co.uk](http://www.enapart.co.uk)  
[sales@enapart.co.uk](mailto:sales@enapart.co.uk)

## THE FEED PUMP TYPE SF

### The variants of the feed pump SF

#### Type SF

- pulsation-free pumping delivery
- clockwise or counter-clockwise rotation
- compact construction
- easy to assemble and to detach
- several sealing types
- electrical heating possible

#### Type SF ATEX



- application in explosive locations acc. to EC-Directives 94/9/EC (ATEX 95)
- area 1 + 21 with temperature control
- area 2 + 22 with/without temperature control
- high degree of safety in potentially explosive atmospheres

#### Type SF...M

magnetic coupling

- hermetically closed
- even at high temperatures and with media difficult to seal
- application acc. to ATEX possible

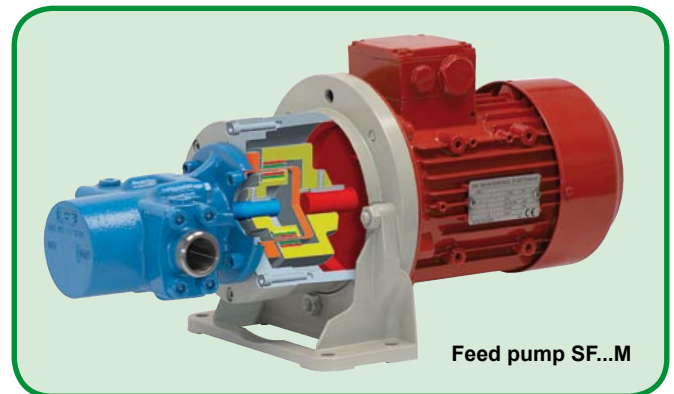
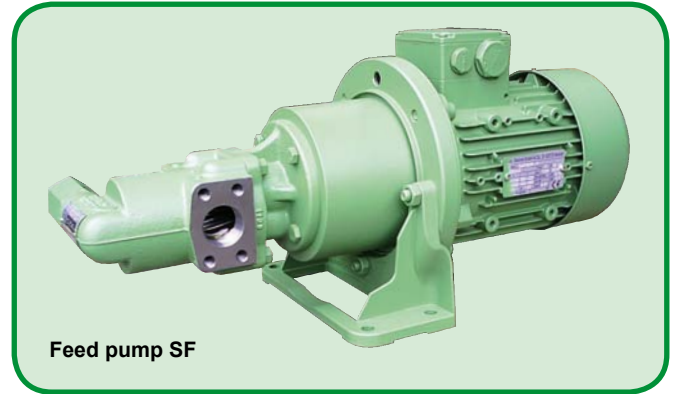

### Range of pumping liquids (extr.)

old oil • fixing agent • bitumen • brake fluid • diesel oil • printing inks • emulsions colours • fats • transmission lubricant glycol • resins • fuel oil • hydraulic oil isocyanate • cocoa butter • cocoa mass refrigeration oil • glue • engine oil • paraffins • vegetable oil • polyglycol oil • polyol lubricating oil • cutting oil • heavy oil • turbine oil • waxes • heat transfer oil • plasticizer oil • drawing oil • and many more

### Reference technical data

Feeding capacity 2 - 1,000 cm<sup>3</sup> / turn

Max. speed 1.800 min<sup>-1</sup>

(Higher speeds possible depending on application.)

Inlet pressure -0.4 to 10 bar

Differential pressure up to 25 bar

Viscosity range 5 to 50,000 mm<sup>2</sup>/s

Temperature range -40°C to +250°C

Depending on the application and varying according to the pump size. Please contact us - we will advise you!

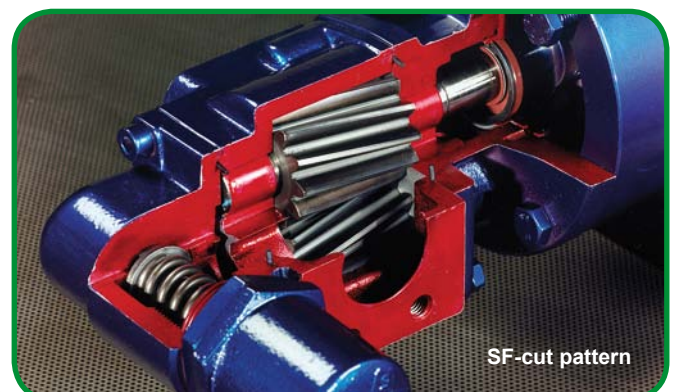

## Main features

Gear pumps of the series SF are particularly suitable for the transport of media that do neither contain solids nor chemically attack the pump materials while ensuring a minimum lubricity.

The standard version is delivered with rotation „clock-wise“. Simply turn the pump housing by 180° which - even retroactively - allows a changing of the rotational direction. This also changes the direction of the flow.

Upon request we supply the pumps with an adjustable pressure relief valve built in the housing for short-term protection against pressure spikes.

In addition to the direct installation of the pumps the execution of the mounting flange and shaft end also permit many variations of the aggregate assembly.

The optimum integration with minimal tolerances of

the pinions and gear wheels cause an extremely smooth running. The use of gear wheels with 12 teeth reduces the delivery flow pulsation. This is an important contribution to noise reduction.

The shaft journals are mounted in composite bearing bushings, which allow a high continuous duty, and ensure long service life.

To accommodate radial and axial forces all pump sizes can be equipped with an antifriction bearing at the driving end.

In supplement to the standard program, we offer a variety of special designs.

## Applications

General machine construction, system engineering, chemical industry, dyestuff industry, filtration, foil manufacture, gear construction, engine construction, paper machines, marine engineering, engineering of lubricating systems, turbine construction, compressors, machine tools, cement systems and many more.

## Constructions

casing parts:	grey cast iron, nodular iron
pinion shafts (SF 2+3):	case hardening steel hardened, helical-toothed, profile-grinded gear teeth
shafts (SF 4-10):	case hardening steel hardened
gear wheels (SF 4-10):	nodular iron ionitrided, helical-toothed
bearings:	composite slide bearings, bronze
shaft seal:	radial shaft seal, mechanical seal or magnetic coupling
pump body seal:	O-Ring NBR (Perbunan®) O-Ring FKM (Viton®) O-Ring PTFE (Teflon®)
Other materials, seals and special designs on request.	

## Use in the ATEX-range



We deliver gear pumps according to **EC-Directives 94/9/EC (ATEX 95)**.

Area 1 + 21 devices that ensure a high level of security and are designed for use in atmospheres that are likely to be explosive. **Shaft seal with temperature control**. Area 2 + 22 devices that ensure a normal level of security and are designed for use in atmospheres that are rarely, and if so, only for a short time potentially explosive. **Shaft seal according to application with/without temperature control**.

## Classification of variants

### Construction types

<b>SF</b>	standard design
<b>D</b>	pressure relief valve (DBV)
<b>F</b>	base
<b>VL</b>	lantern according to VDMA
<b>VLM</b>	lantern with motor according to VDMA
<b>VLMF</b>	lantern w. motor and motor base acc. to VDMA
<b>VLFM</b>	lantern w. base and motor acc. to VDMA

### Shaft seals

<b>R</b>	radial shaft seal (WDR)
<b>G</b>	mechanical seal (GLRD)
<b>GGK</b>	double mechanical seal with support bearing and quench recipient
<b>KR</b>	ball bearing with radial shaft seal
<b>M</b>	magnetic coupling

## Ordering example

**SF 4/63 RD-VLFM**

<b>SF</b>	pump type
<b>4</b>	size
<b>63</b>	geometric displacement (cm <sup>3</sup> )
<b>R</b>	radial shaft seal
<b>D</b>	pressure relief valve
<b>VLF</b>	lantern with base
<b>M</b>	drive motor



## Details in section

Optional pressure relief valve **DBV**

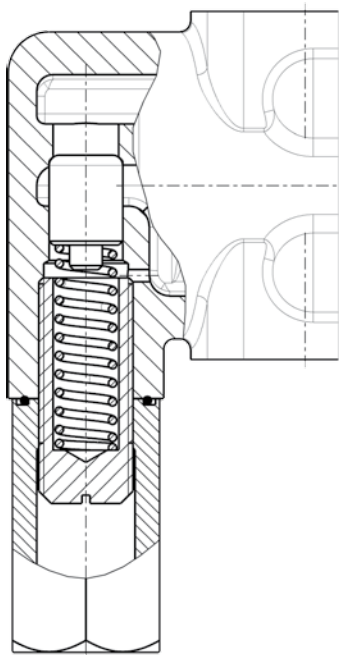

Shaft seal **R (WDR)**

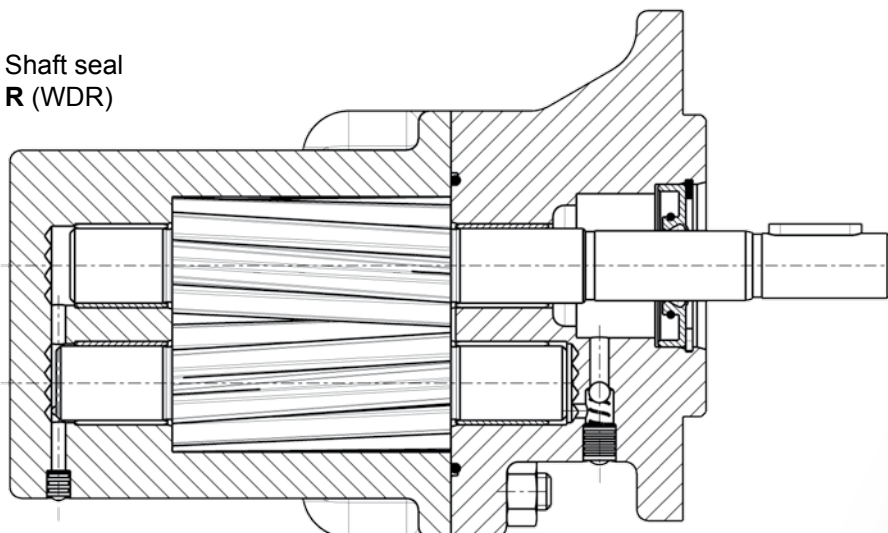

Shaft seal **KR**

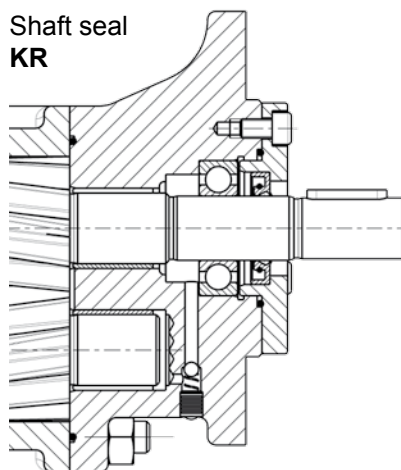

Shaft seal **G (GLRD)**

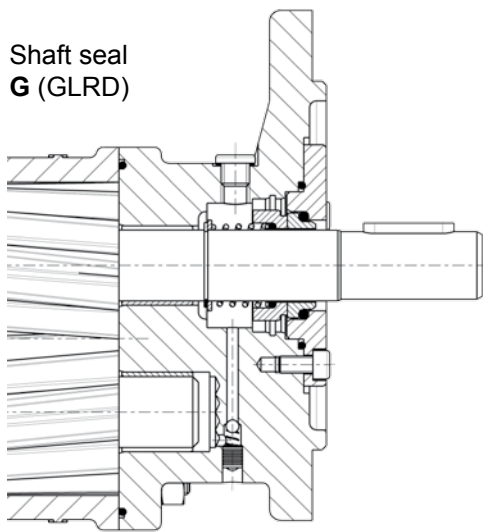

Shaft seal **GGK**

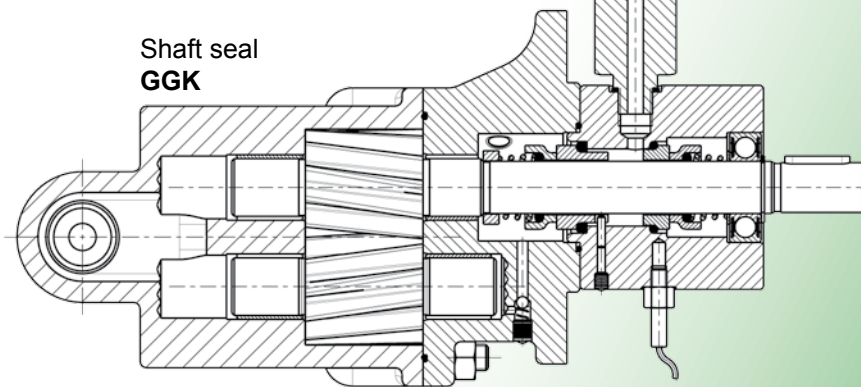

Shaft seal **M**

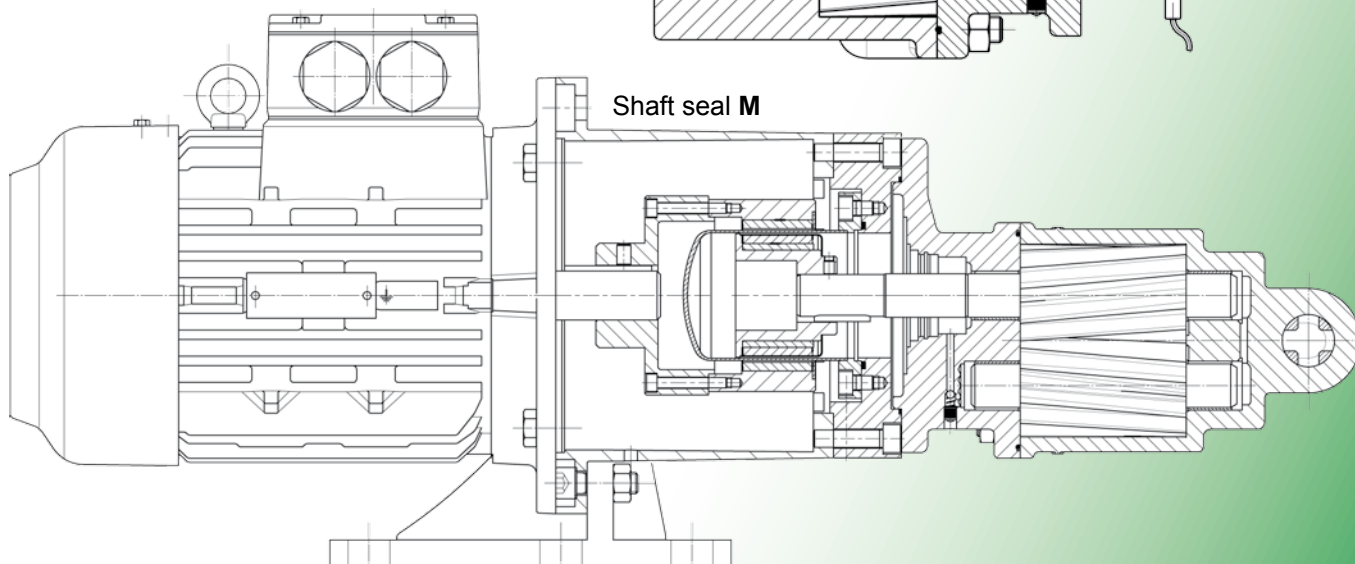

# Components overview

## Example composition

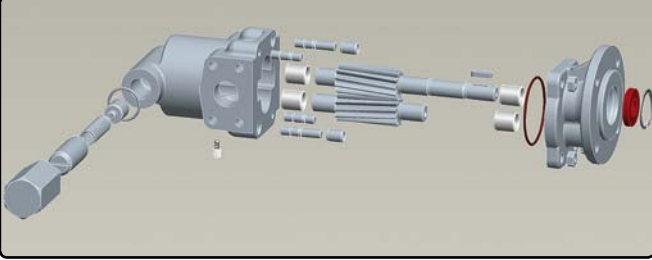

The parts of an SF pump presented in the components overview are to illustrate the variety of this type of pump.

For the sake of clarity, not all optional components are shown. Here we show the essential parts.

Gebr. Steimel is your partner for individual solutions. Talk to us without obligation if you are interested in a consultation on the standard components or even in a customized version besides the range shown here.

The marking of the ATEX-compliant assemblies made here is not sufficient for an aggregate compilation. ATEX units require advice.

### Casing SF2-SF10

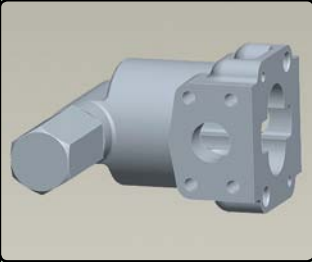

Standard design

### Flange SAE

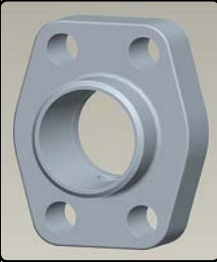

weld

### Flange SAE



screw in

### Casing SF2-SF10

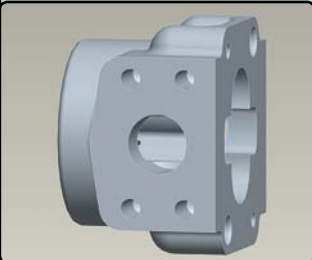

without DBV

### Rotating parts

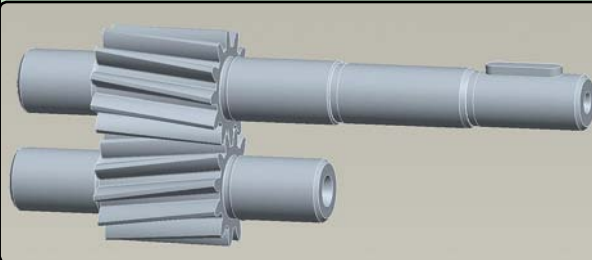

### Cover

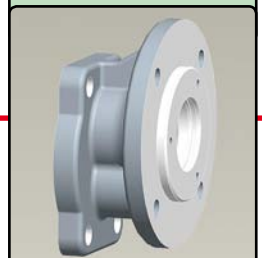

### Cover

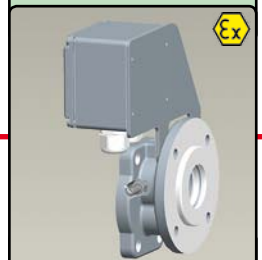

Temperat. control

### Casing nur SF2

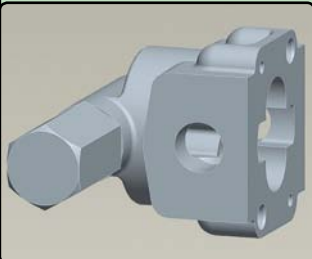

with DBV, with thread

- Main structural components of the pump
- Connection options at the pressure connection and suction port
- Optional components

### Casing nur SF2

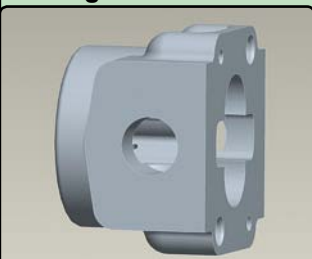

with thread

### Recipient tank



QB500

### Recipient tank



QB1000

### Recipient tank



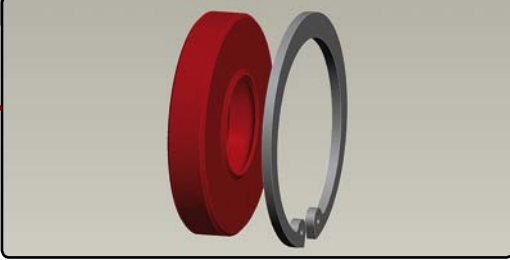

QBS1000

Radial shaft seal **WDR**

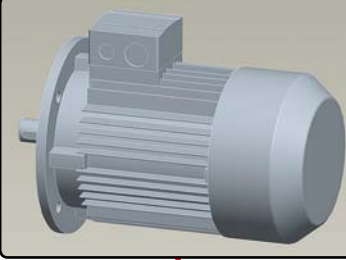

Electric motor



Electric motor acc. to ATEX 

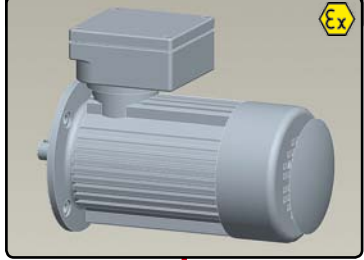

Mechanical seal **GLRD** 

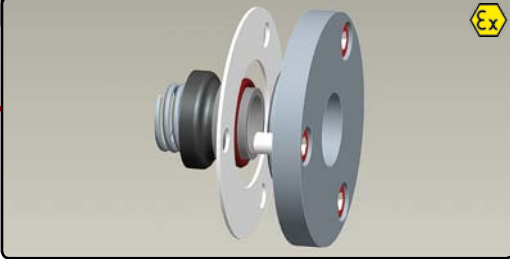

Coupling

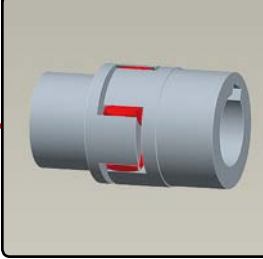

Lantern

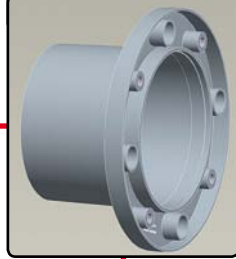

Double mechanical seal **GGK** 



ball bearing with radial shaft seal **KR**

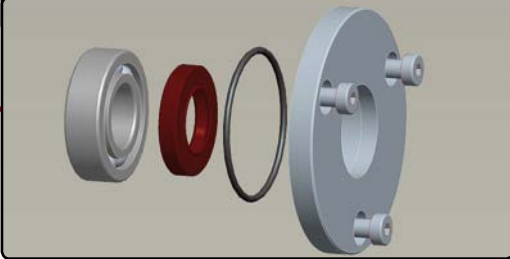

External drive



Magnetic coupling **M** 

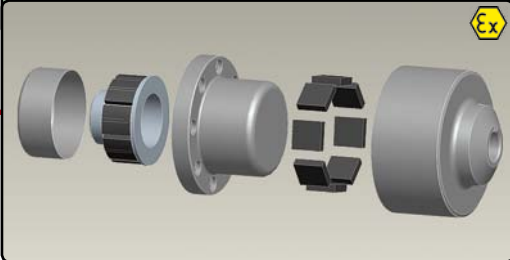

Base

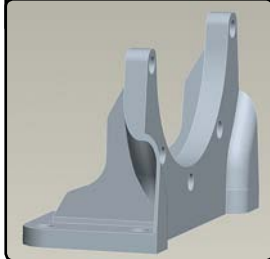

PT100 



# Throughputs

Size	Pump rate	Pressure p (bar) at speed n = 1.450 min <sup>-1</sup>										Pump rate cm <sup>3</sup> /turn
	Rating	2	4	6	8	10	12	14	16	20	25	
SF 2/2	l/min	3.48	3.19	2.99	2.70	2.50						2
	NkW	0.10	0.10	0.10	0.12	0.13						
	Motor <sup>1</sup> kW	0.25	0.25	0.25	0.25	0.25						
SF 2/3	l/min	4.32	4.06	3.87	3.67	3.48						3
	NkW	0.10	0.10	0.12	0.15	0.17						
	Motor <sup>1</sup> kW	0.25	0.25	0.25	0.25	0.25						
SF 2/4	l/min	5.32	5.12	4.93	4.64	4.45	4.13	3.96	3.77			4
	NkW	0.10	0.13	0.16	0.18	0.21	0.24	0.26	0.29			
	Motor <sup>1</sup> kW	0.25	0.25	0.25	0.25	0.37	0.37	0.37	0.37			
SF 2/5	l/min	7.44	6.96	6.67	6.28	6.09	5.70	5.41	5.12	4.74		5
	NkW	0.12	0.15	0.18	0.21	0.24	0.28	0.31	0.34	0.40		
	Motor <sup>1</sup> kW	0.25	0.25	0.25	0.37	0.37	0.37	0.55	0.55	0.55		
SF 2/6	l/min	9.38	8.89	8.51	8.12	7.83	7.44	7.06	6.67	5.99		6
	NkW	0.13	0.17	0.21	0.25	0.29	0.32	0.36	0.40	0.47		
	Motor <sup>1</sup> kW	0.25	0.25	0.37	0.37	0.37	0.55	0.55	0.55	0.75		
SF 2/8	l/min	11.70	11.21	10.63	10.15	9.67	9.18	8.80	8.31	7.35	6.28	8
	NkW	0.15	0.19	0.24	0.29	0.33	0.37	0.42	0.45	0.54	0.65	
	Motor <sup>1</sup> kW	0.25	0.25	0.37	0.37	0.55	0.55	0.55	0.55	0.75	1.1	
SF 2/10	l/min	15.47	14.99	14.50	14.11	13.73	13.34	12.95	12.47	11.60	10.63	10
	NkW	0.18	0.23	0.28	0.33	0.38	0.42	0.46	0.51	0.61	0.72	
	Motor <sup>1</sup> kW	0.25	0.37	0.37	0.55	0.55	0.55	0.75	0.75	0.75	1.1	
SF 2/13	l/min	19.53	18.85	18.27	17.59	17.11	16.53	16.05	15.56	14.60	13.44	13
	NkW	0.21	0.26	0.32	0.37	0.42	0.47	0.53	0.58	0.69	0.82	
	Motor <sup>1</sup> kW	0.37	0.37	0.55	0.55	0.55	0.75	0.75	0.75	1.1	1.1	
SF 2/16	l/min	24.75	23.97	23.39	22.72	22.14	21.46	20.88	20.20	19.14	17.40	16
	NkW	0.24	0.31	0.38	0.45	0.52	0.60	0.67	0.74	0.89	1.07	
	Motor <sup>1</sup> kW	0.37	0.37	0.55	0.55	0.75	0.75	1.1	1.1	1.1	1.5	
SF 2/20	l/min	29.77	28.90	28.03	27.16	26.39	25.62	24.84	23.97	22.43	20.69	20
	NkW	0.26	0.36	0.44	0.53	0.63	0.72	0.82	0.92	1.11	1.35	
	Motor <sup>1</sup> kW	0.37	0.55	0.55	0.75	0.75	1.1	1.1	1.1	1.5	2.2	
SF 3/25	l/min	38.3	37.9	37.5	37.1	36.7	36.4	36.0	35.6	34.8	33.8	25
	NkW	0.46	0.60	0.73	0.88	1.00	1.14	1.28	1.42	1.69	2.03	
	Motor <sup>1</sup> kW	0.75	0.75	1.1	1.1	1.5	1.5	2.2	2.2	2.2	3	
SF 3/32	l/min	51.5	50.8	50.3	49.9	49.5	48.9	48.5	48.0	47.2	45.9	32
	NkW	0.60	0.77	0.95	1.12	1.29	1.45	1.67	1.80	2.17	2.57	
	Motor <sup>1</sup> kW	0.75	1.1	1.5	1.5	2.2	2.2	2.2	2.2	3	4	
SF 3/40	l/min	61.9	61.4	60.9	60.2	59.6	59.0	58.5	57.8	56.7	55.4	40
	NkW	0.62	0.81	1.00	1.20	1.40	1.60	1.80	2.01	2.42	2.90	
	Motor <sup>1</sup> kW	0.75	1.1	1.5	1.5	2.2	2.2	2.2	3	3	4	
SF 3/50	l/min	73.7	72.7	72.0	71.1	70.2	69.4	68.6	67.6	65.7	63.8	50
	NkW	0.77	0.98	1.23	1.47	1.74	1.95	2.22	2.46	2.95	3.58	
	Motor <sup>1</sup> kW	1.1	1.5	1.5	2.2	2.2	3	3	3	4	5.5	
SF 4/63	l/min	92.3	91.8	90.9	90.4	89.4	88.9	88.0	87.5	86.0	84.1	63
	NkW	1.06	1.34	1.64	1.93	2.24	2.51	2.80	3.14	3.77	4.54	
	Motor <sup>1</sup> kW	1.5	2.2	2.2	3	3	3	4	4	5.5	5.5	
SF 4/80	l/min	110	109	108	107	106	105	104	103	101	99	80
	NkW	1.14	1.50	1.87	2.21	2.58	2.97	3.24	3.57	4.32	5.18	
	Motor <sup>1</sup> kW	1.5	2.2	3	3	4	4	4	5.5	5.5	7.5	
SF 4/90	l/min	129	127	126	124	123	121	120	118	116	114	90
	NkW	1.16	1.61	2.04	2.45	2.83	3.40	3.72	4.09	5.02	6.06	
	Motor <sup>1</sup> kW	1.5	2.2	3	3	4	5.5	5.5	5.5	7.5	7.5	

NkW = Nominal power consumption at the pump shaft relative to a viscosity of 50-150 mm<sup>2</sup>/s (cSt).  
 The flow rate (l / min) refers 1/min to 1.450. It is reduced according to the rated speed of the engine. Deviation of flow ±5%.  
 A viscosity of less than 50 mm<sup>2</sup>/s reduces the capacity.  
<sup>1</sup> Required drive power (20% surcharge is included).

Subject to change.

# Throughputs

Size	Pump rate	Pressure p (bar) at speed n = 1,450 min <sup>-1</sup>										Pump rate cm <sup>3</sup> /turn
	Rating	2	4	6	8	10	12	14	16	20	25	
<b>SF 4/112</b>	l/min	148	146	144	142	140	139	137	135	132	128	112
	NkW	1.24	1.72	2.24	2.70	3.35	3.67	4.30	4.80	5.80	7.06	
	Motor <sup>1</sup> kW	1.5	2.2	3	4	4	5.5	5.5	7.5	7.5	11	
<b>SF 6/120</b>	l/min	176	175	174	173	171	170	169	167	165		120
	NkW	1.59	2.17	2.75	3.38	3.96	4.54	5.12	5.70	6.86		
	Motor <sup>1</sup> kW	2.2	3	4	5.5	5.5	5.5	7.5	7.5	11		
<b>SF 6/132</b>	l/min	193	192	191	190	188	187	186	185	183		132
	NkW	1.79	2.48	3.19	3.91	4.59	5.32	5.99	6.72	8.12		
	Motor <sup>1</sup> kW	2.2	3	4	5.5	5.5	7.5	7.5	11	11		
<b>SF 6/160</b>	l/min	229	228	227	225	224	223	222	221	219		160
	NkW	1.98	2.80	3.67	4.49	5.32	6.19	7.01	7.83	9.52		
	Motor <sup>1</sup> kW	3	4	5.5	5.5	7.5	7.5	11	11	15		
<b>SF 6/180</b>	l/min	263	262	261	259	258	256	255	254	252		180
	NkW	2.17	3.19	4.17	5.17	6.14	7.15	8.12	9.09	11.12		
	Motor <sup>1</sup> kW	3	4	5.5	7.5	7.5	11	11	11	15		
<b>SF 8/212</b>	l/min	318	316	314	311	308	304	300	296	290		212
	NkW	2.7	3.8	4.9	6.0	7.2	8.3	9.6	10.7	13.0		
	Motor <sup>1</sup> kW	4	5.5	7.5	7.5	11	11	15	15	18.5		
<b>SF 8/250</b>	l/min	370	368	366	363	360	356	352	348	342		250
	NkW	3.3	4.6	6.0	7.4	8.8	10.2	11.3	12.5	15.4		
	Motor <sup>1</sup> kW	4	5.5	7.5	11	11	15	15	15	18.5		
<b>SF 8/300</b>	l/min	445	443	440	437	434	430	426	422	416		300
	NkW	3.7	5.3	6.9	8.6	10.2	11.7	13.4	15.0	18.3		
	Motor <sup>1</sup> kW	5.5	7.5	11	11	15	15	18.5	18.5	22		
<b>SF 8/350</b>	l/min	518	515	512	508	504	500	495	490	483		350
	NkW	4.5	6.4	8.3	10.4	12.3	14.2	16.1	18.0	22.1		
	Motor <sup>1</sup> kW	5.5	7.5	11	15	15	18.5	22	22	30		
<b>SF 8/400</b>	l/min	592	589	586	582	578	574	569	564			400
	NkW	6.0	8.0	9.9	11.9	13.9	16.0	18.1	20.1			
	Motor <sup>1</sup> kW	7.5	11	15	15	18.5	22	22	30			
<b>SF 8/450</b>	l/min	665	661	657	653	649	645	640	635			450
	NkW	6.8	9.2	11.5	13.7	16.1	18.3	20.6	22.9			
	Motor <sup>1</sup> kW	11	11	15	18.5	22	22	30	30			
<b>SF 10/500</b>	l/min	715	704	694	677	667	657	647	640			500
	NkW	6.6	9.35	12.1	14.9	17.6	20.4	22.6	25.3			
	Motor <sup>1</sup> kW	11	11	15	18.5	22	30	30	30			
<b>SF 10/575</b>	l/min	835	825	815	800	785	770					575
	NkW	7.7	10.9	14.1	17.3	20.5	23.8					
	Motor <sup>1</sup> kW	11	15	18.5	22	30	30					
<b>SF 10/650</b>	l/min	965	955	945	930	915	900					650
	NkW	8.8	12.5	16.2	19.8	23.5	27.1					
	Motor <sup>1</sup> kW	11	15	22	30	30	37					
<b>SF 10/750</b>	l/min	1,075	1,055	1,035	1,015	995	970					750
	NkW	9.9	14.0	18.2	22.3	26.4	30.6					
	Motor <sup>1</sup> kW	15	18.5	22	30	37	37					
<b>SF 10/875</b>	l/min	1,258	1,238	1,218	1,198	1,178						875
	NkW	11.6	16.4	21.2	26.0	30.8						
	Motor <sup>1</sup> kW	15	22	30	37	37						
<b>SF 10/1000</b>	l/min	1,440	1,420	1,400	1,380	1,360						1,000
	NkW	13.2	18.7	24.2	29.7	35.2						
	Motor <sup>1</sup> kW	18.5	22	30	37	45						

NkW = Nominal power consumption at the pump shaft relative to a viscosity of 50-150 mm<sup>2</sup>/s (cSt).  
 The flow rate (l/min) refers 1/min to 1,450. It is reduced according to the rated speed of the engine. Deviation of flow ±5%.  
 A viscosity of less than 50 mm<sup>2</sup>/s reduces the capacity.  
<sup>1</sup> Required drive power (20% surcharge is included).

Subject to change.



## Model examples

### For general machine construction, engineering

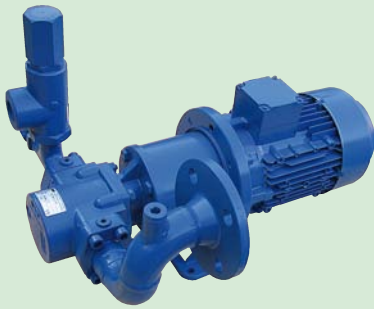

e.g. lubricating pump in an oil supply system with filter and oil coolers

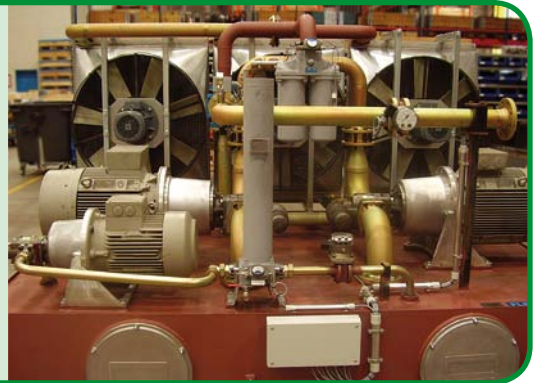

### For the dyestuff and lacquer industry



e.g. binders pump (resins) according to ATEX with double GLRD (mechanical seal), quench recipient and temperature control



### For the chemical industry, petrochemistry



e.g. solvent pump according to ATEX with magnetic coupling and temperature control



### For the chocolate industry

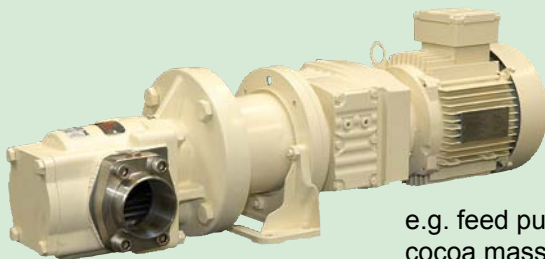

e.g. feed pump in chocolate or cocoa mass systems



# Steimel

## Gebr. Steimel GmbH & Co. Pumps and centrifuges

P.O.Box 1565  
53762 Hennef

Johann-Steimel-Platz 1  
53773 Hennef  
Deutschland • Germany • Allemagne • Alemania

Phone: +49 (0) 2242 8809 -0  
Fax: +49 (0) 2242 8809 -160

<http://www.steimel.com> • [vtp@steimel.com](mailto:vtp@steimel.com)